

**T&J**  
www.tjelec.com







## T&J Electric

T&J Electric is first and foremost a manufacturer, we are one of the largest LV electrical switch and socket makers in the world, with a fully owned production facility with over 80,000 sqm "under roof".

T&J Electric has manufactured British standard wiring devices sold in the UK market with a value in excess of USD 50 million over the past 20 years and now we will enter the continental European project supply market.

T&J Electric is one of the very few international wiring device brands that is installed in various properties of almost every major international 5 star hotel chain including Four Seasons, Oberoi, Hyatt, Marriott, Hilton, Intercontinental, Sofitel and the Waldorf Astoria.

T&J Electric continues to win wiring device supply contracts for some of the most prestigious hospitality projects worldwide and in general is conducting more business each day in in the MENA region, Europe, Asia, Latin America, Oceania and sub-Saharan Africa .

T&J Electric can supply a high-value product line factory-direct or through one of our industry-expert distribution partners for major new building or renovation projects that require standard and / or bespoke stainless steel, iron alloy, aluminium or plastic wall plates, hotel specialty products like shaver sockets or key cards, audio-video connections and a variety of multi-media hub solutions.

T&J manufactures IEC certified sockets in many different standards including British, German, French, Swiss, Italian, South African, Brazilian, American and NZ/Australian and is a leader in universal socket design.

Please connect with T&J Electric today for more details about our high-quality products or to schedule a visit to one of our international factory showrooms or with one of our expert industry distribution partners.



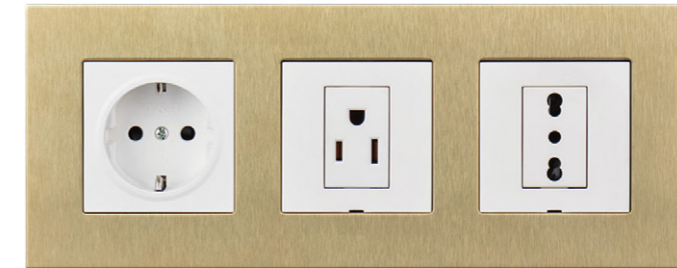

Wide selection of painted colours, simulated wood grain finishes, aluminium, premium 1.5 mm stainless steel - all wall plates are available in almost any finish imaginable to meet your interior design scheme and project specifications.





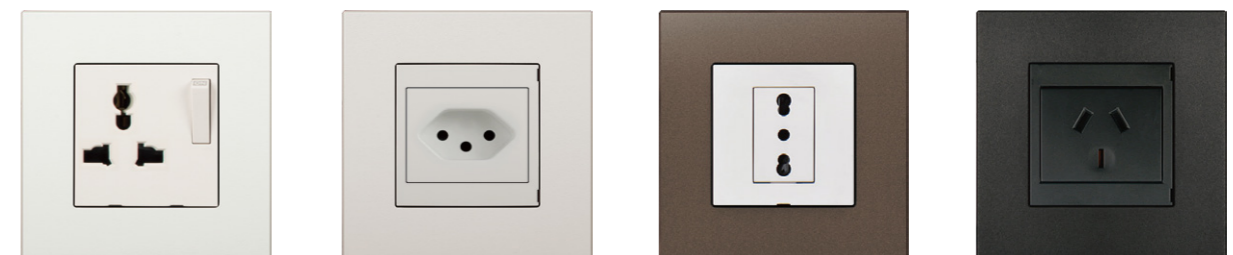











Bespoke (custom-made) products can be made to meet almost any specific end-user requirement from etched icons, text or patterns to special customised metal finishes or unique painted colours or electro-plated polycarbonate plates.



A variety of mechanisms are available, including most types of switches, certified power sockets in a wide variety of national standards, audio-video connections, telecoms, USB chargers and a complete line of hotel products.

Multi-gang plates (up to 5 gang) in polycarbonate, or stainless steel for a nearly unlimited variety of mechanism combinations to satisfy most project requirements.

**Switches**





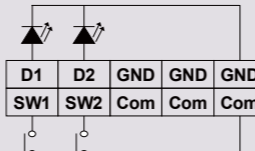









Product	Model No.	Description
	JC271-B-W-A	10A 1 Gang 1 Way Bell Switch
	JC271-W-A JC271-2-W-A JC261-W-A	10AX 1 Gang 1 Way Switch 10AX 1 Gang 2 Way Switch 10A 1 Gang 1 Way Retractive Switch
	JC271L-W-A JC271L-2-W-A JC261L-W-A	10AX 1 Gang 1 Way Switch With LED Indicator 10AX 1 Gang 2 Way Switch With LED Indicator 10A 1 Gang 1 Way Retractive Switch With LED Indicator
	JC272-W-A JC272-2-W-A JC262-W-A	10AX 2 Gang 1 Way Switch 10AX 2 Gang 1 Way Switch 10A 2 Gang 1 Way Retractive Switch
	JC272L-W-A JC272L-2-W-A JC262L-W-A	10AX 2 Gang 1 Way Switch With LED Indicator 10AX 2 Gang 2 Way Switch With LED Indicator 10A 2 Gang 1 Way Retractive Switch With LED Indicator
	JC273-W-A JC273-2-W-A JC263-W-A	10AX 3 Gang 1 Way Switch 10AX 3 Gang 2 Way Switch 10A 3 Gang 1 Way Retractive Switch
	JC223-W-A	10AX Blind Switch
	JC222A-W-A	6A 2 Gang 2 Way Shutter Switch With Center Off
	JC2720L-DP-W-A	20AX 1 Gang DP Switch With LED Indicator
	JC245L-W-A	45A 1 Gang DP Switch With LED Indicator
	JC2721L-W-A	3.3-24V DC 1 Gang Smart Switch
	JC2722LA-W-A	3.3-24V DC 1+1 Gang Smart Switch
	JC2722L-W-A	3.3-24V DC 2 Gang Smart Switch
	JC2723L-W-A	3.3-24V DC 1+2 Gang Smart Switch
	JC2724LA-W-A	3.3-24V DC 2+2 Gang Smart Switch

**Smart Switches**  
 1 Gang : W4211QL-A1B  
 2 Gang : W4212QL-A1B  
 LED colour : Blue  
 LED voltage : 3.3V DC  
 (common cathode)  
 Switch : 3.3~24V DC



















Smart switches must be used in conjunction with T&J Electric B10 or B12 control modules  
 Please contact T&J Electric for more details

**Sockets**

Product	Model No.	Description
	JC8110CH-W-A	10A 1 Gang Swiss Socket (SEV Certified)
	JC8116CH-W-A	16A 1 Gang Swiss Socket (SEV Certified)
	JC8110-W-A	1 Gang 10A Brazilian Socket
	JC8120-W-A	1 Gang 20A Brazilian Socket
	JC813SA-W-A JC813SA-DP-W-A	13A 1 Gang British Switched Socket 13A 1 Gang British DP Switched Socket
	JC818-W-A	13A 1 Gang 2 Pin + Earth Universal Socket
	JC8318S-W-A	13A 1 Gang Switched 2 Pin + Earth Universal Socket
	JC8318USBC-W-A	13A 1 Gang 2 Pin + Earth Universal Socket With 2 Gang USB Socket (2A)
	JC816U-W-A	16A 1 Gang 2 Pin + Earth German Socket (VDE Certified)
	JC816V-W-A	16A 1 Gang 2 Pin + Earth French Socket (VDE Certified)
	JC8416U-W-A	10/16A 1 Gang 2 Pin Euro American Socket
	JC8416U2-W-A	10/16A 2 Gang 2 Pin Euro American Socket
	JC8416V-W-A	16A 1 Gang 2 Pin + Earth Universal Socket
	JC8315U-W-A	16A 1 Gang DP Flat Pin Socket
	JC8315V-W-A	15A 1 Gang 2 Pin + Earth Socket

















## Sockets















Product	Model No.	Description
	JC8316V-W-A	16A 1 Gang Flat Pin Socket
	JC8810V-W-A	10A 2 Pin + Earth AUS/NZ Socket (horizontal)
	JC8814VS-W-A	10A 2 Pin + Earth AUS / NZ Socket (round earth pin, auto-disconnecting)
	JC8811V-W-A	10A 2 Pin + Earth AUS/NZ Socket (vertical)
	JC8710-W-A	10A/16A Universal Italian/Euro Socket
	JC8706-W-A	6A 1 Gang 24V 2 Pin Socket
	JC8016-W-A	16A 1 Gang India/ South Africa Socket
	JC8515-W-A	15A 1 Gang BS Round Pin Socket
	JC8505-W-A	5A 1 Gang BS Round Pin Socket
	JC8715-W-A	10A/15A 1 Gang 2 Pin Universal Socket
	JC8718-W-A	10A/16A 1 Gang Bi-passo Italian Socket
	JC8728-W-A	10A/16A 1 Gang Bi-passo/ schuko Universal Socket
	JC5601-W-A	20A 1 Gang Flex Outlet (pull-through cable)
	JC525-W	25A Connection Unit
	JC813SD-W	13A 2 Gang British Switched Socket
	JC828-W	115/230V Shaver Socket With Overcurrent Protection

\*note JC828, JC1514 and JC813SD all require twin 3 x 6 box









## Hotel Series

Product	Model No.	Description
	JC801-B-W-A	24V Bell Push Switch
	JC2C-DM-W-A	"Do Not Disturb" + "Make Up Room" Indicator
	JC2C-DMB-W-A	4A Bell Switch with "Do Not Disturb" + "Make Up Room" indicator
	JC2743DMB-W-A	10A Bell Push Switch With "Do Not Disturb" + "Make Up Room" indicator (low voltage pin header)
	JC8201BE-W-A	Doorbell Buzzer
	JC2-AL-W-A	SOS Switch (Panic Button)
	JC2-V-W-A	1 Gang Volume Switch
	JC2-LIR-W-A	1000W 230V IR Motion Detector With Fire Control Outlet
	JC2-M2-W-A JC2-DCM2-W-A	600W 230V 1 Gang Dimmer (Push On/Off) 1~10V 1 Gang DC Output Dimmer Only For Dimmable Electronic Ballast (Push On/Off)
	JC2-TC-W-A JC2-TC9-W-A	100-250V LCD Thermostat 9-12V DC LCD Thermostat
	JC6-2KT-W-A JC8-2KT-W-A JC9-2KT-W-A JC6-KT9-W-A JC8-KT9-W-A JC9-KT9-W-A	20A 100-240V Keycard Switch With Time Delay 20A 100-240V Low Frequency RFID Keycard Switch With Time Delay 20A 100-240V High Frequency RFID Keycard Switch With Time Delay 10A 9-24V Keycard Switch With Time Delay, ELV, Dry-contact Output 10A 9-24V Low Frequency RFID Keycard Switch With Time Delay, ELV, Dry-contact Output 10A 9-24V High Frequency RFID Keycard Switch With Time Delay, ELV, Dry-contact Output
	JC1512-W-A+W2600	1W LED Night Light / Stair Indicator
	JC1512-W-A+W2747	3-400W 230V Dimmer (trailing edge, EMC, push on /off)
	JC1512-W-A+W2726	400VA 230V Fan Control (push on /off)

Telecoms and AV

Product	Model No.	Description
	JC8231PC-W-A JC8241PC-W-A	1 Gang RJ45 Cat.7 Data Socket 1 Gang RJ45 Cat.8 Data Socket
	JC821PC-W-A JC841PC-W-A	1 Gang RJ45 Cat.6 Data Socket 1 Gang RJ45 Cat.6a Data Socket
	JC822PC-W-A	2 Gang RJ45 Cat.6 Data Socket
	JC811-6TU-W-A	1 Gang RJ11 Telephone Socket (6 Pin)
	JC811PC-6TU-W-A	1 Gang RJ45 Cat.6 Data Socket + RJ11 Telephone Socket (6 Pin)
	JC801TV-PC-W-A	1 Gang TV Socket With Surge Protection + RJ45 Cat.6 Data Socket
	JC8201TM-W-A	1 Gang BT Master Telephone Socket
	JC801TV-W-A	1 Gang TV Socket With Surge Protection
	JC801ETV-W-A	1 Gang Sat. TV Socket
	JC801HDMI-W-A	1 Gang HDMI Outlet
	JC811AO-W-A	1 Gang Audio Outlet
	JC811VO-W-A	1 Gang Video RCA Outlet
	JC801AVO-W-A	1 Gang Video Socket + 1 Gang Stereo Audio RCA Outlet
	JC811VGA-W-A	1 Gang VGA Outlet (Double Female)
	JC811EO-W-A	1 Gang $\phi$ 3.5 Stereo Headphone Outlet
	JC811USBA-W-A	1 Gang 2A USB Power Charger

Telecoms and AV

Product	Model No.	Description
	JC8332LUSB-W-A	18W 100-240V Dual USB Power Charger
	JC8211USB-W-A	USB Outlet (Data Only)
	JC8102LUSB-W-A	Type C + Type A Quick Charger USB (quick charge is available if only one port is used)
	JC1511-W-A	1 Gang Modular Plate
	JC1512-W-A	2 Gang Modular Plate
	JC1514-W-A	4 Gang Modular Plate
	JC1401F	1 Gang Spray Proof Plate
	JC1001-W-A	1 Gang Blank Plate

• Please contact us for a wider range of module selections, IP66/55 boxes, media hubs, and a variety of floor sockets that are not listed above.  
• Compatible with Palladiom frame by Lutron USA.



Ordering Code

JC8318S-W - LWH - A

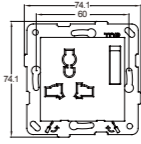
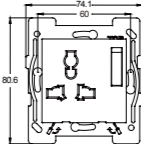

Code	Colour/Texture	Code	Colour/Texture
LWH	White	LGR	Gray
LAL	Almond	LBL	Black
LLA	Light Almond	LBE	Beige
LIV	Ivory	LTP	Taupe
LBR	Brown	LSI	Sienna

Product	Code	Description
	(No Code Needed)	Non-standard Bracket Fits round boxes, for both horizontal + vertical installations
	A	Default Bracket Fits both British + round boxes, for horizontal installation only

Plates are also available in 86mm height

Scale: mm

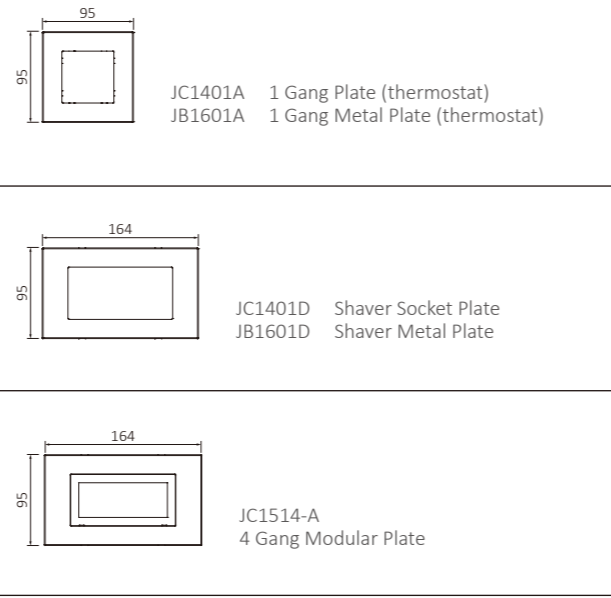
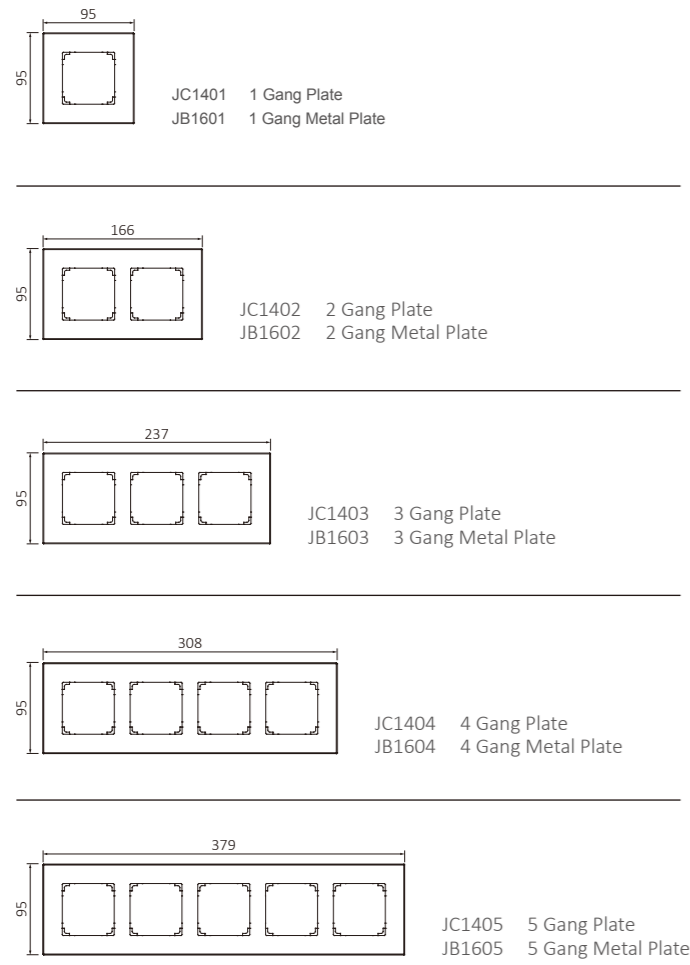

Ordering Code For Plate

JC1401 - LWH

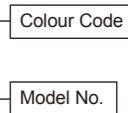

Achitectoral		Achitectoral Metal	
WH	White	SS	Stainless Steel
IW	Ivory White	MBR	Matt Brass
PS	Pearl Silver	PB	Polished Brass
CS	Cola Silver	PC	Polished Chrome
ST	Matt Black	BN	Black Nickel
CGO	Coffee Gold	BZ	Bronze
LWH	White	PN	Pearl Nickel
LAL	Almond	LBB	Bright Brass
LLA	Light Almond	LSB	Satin Brass
LIV	Ivory	LBC	Bright Chrome
LBR	Brown	LSC	Satin Chrome
LGR	Gray	LBN	Bright Nickel
LBL	Black	LSN	Satin Nickel
LBE	Beige	LPG	Polised Graphite
LTP	Taupe	LQB	Antique Brass
LSI	Sienna	LQZ	Antique Bronze

For other colours and finishes, please contact T&J ELECTRIC.

Single gang Assembly

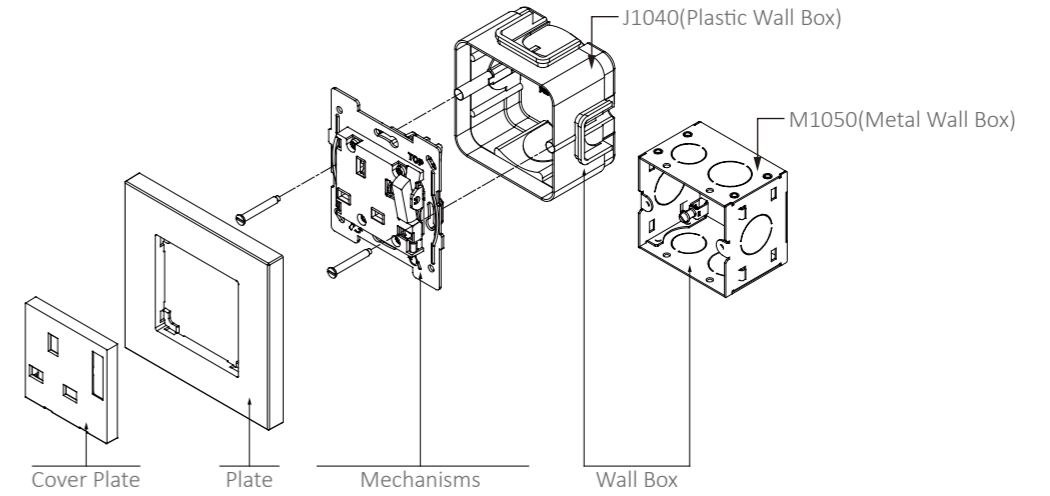

Multigang Assembly

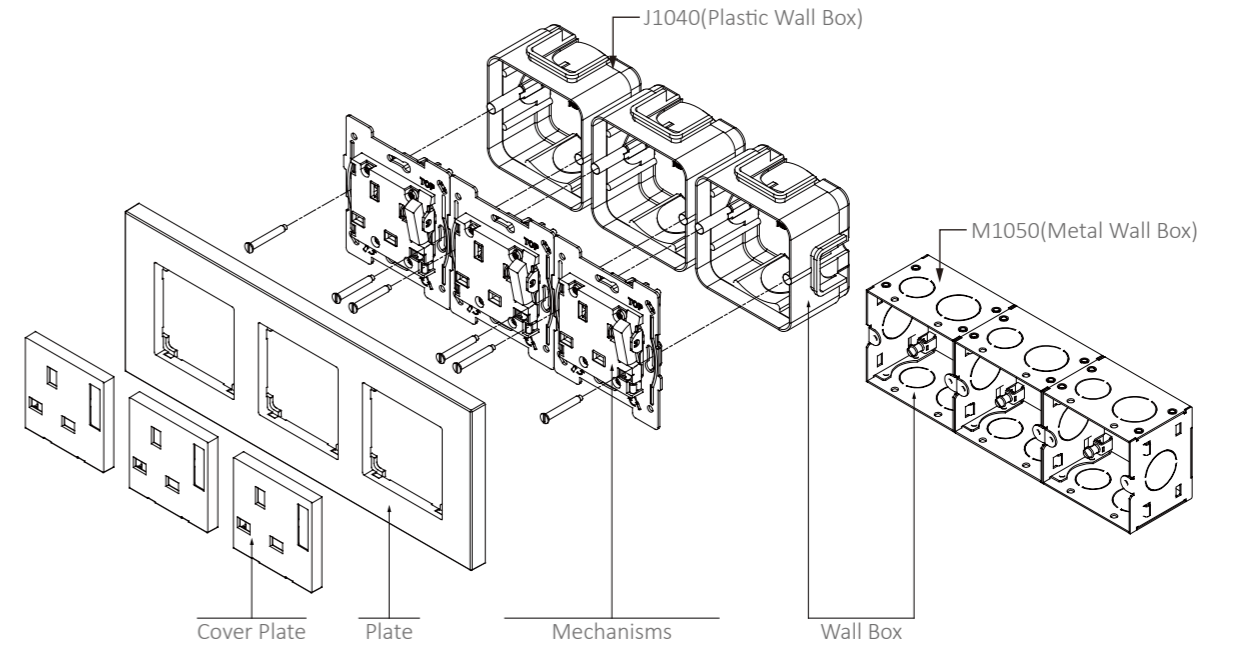

Plastic (Flush Mounting)

Scale: mm

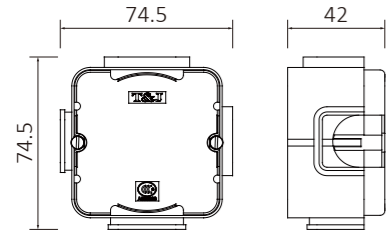

J1040

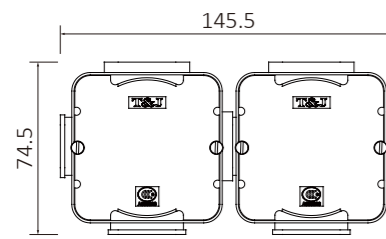

J1040x2

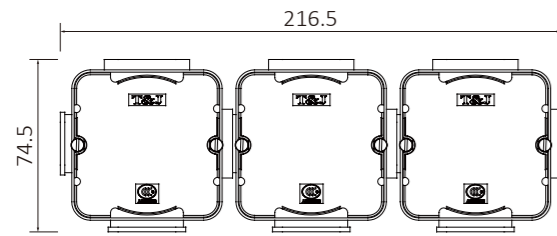

J1040x3

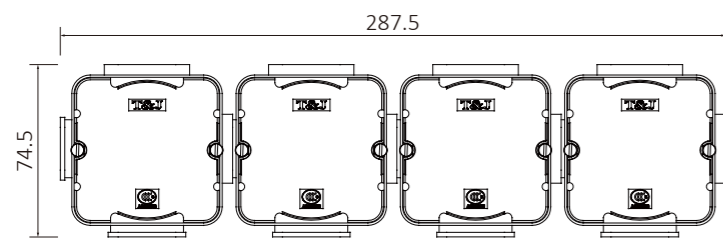

J1040x3

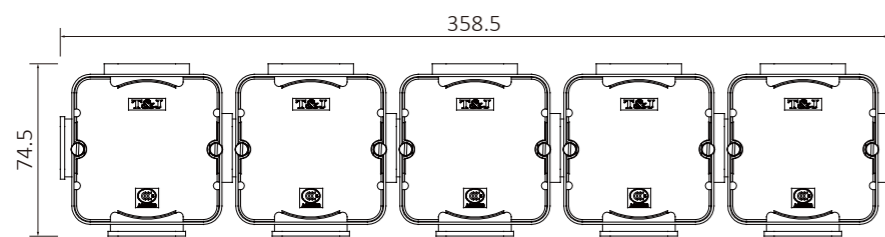

J1040x5

Metal (Flush Mounting)

Scale: mm

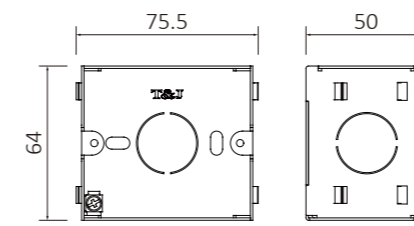

M1050

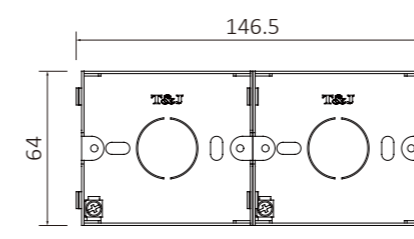

M1050x2

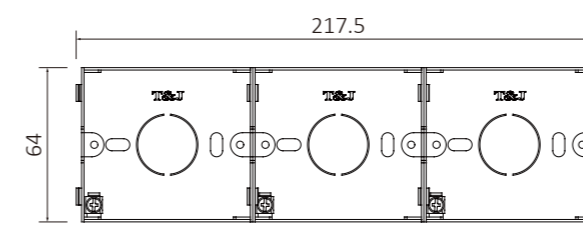

M1050x3

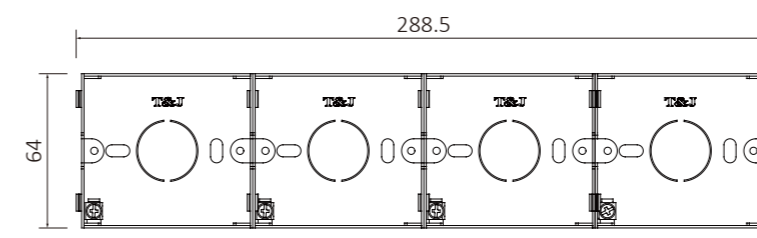

M1050x4

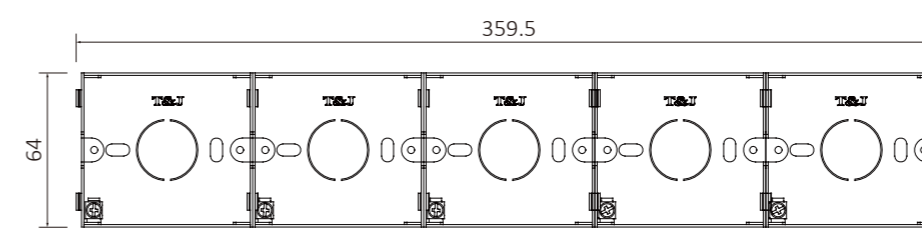

M1050x5

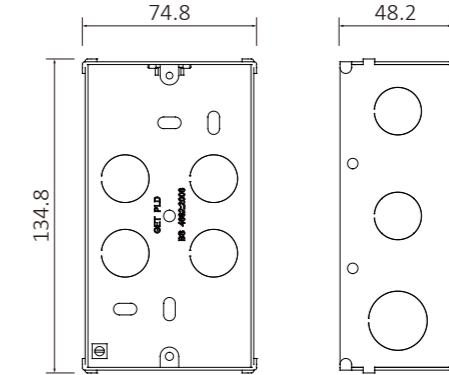

M1047D